

EVOLoop

Activation, presence and protection  sensor for automatic barriers

User's Guide for software version 0100 and higher - (refer to tracking label on the product)

1. INTENDED USE

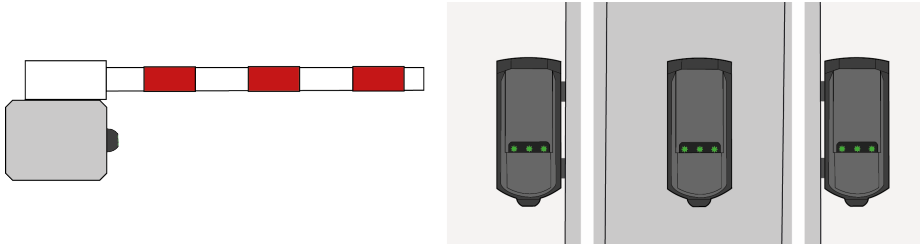

The EVOLOOP is an activation and presence sensor for automatic barriers with MoWa inside technology based on FMCW principles.





MoWA

INSIDE

PROTECTION

The EVOLOOP can be used as a safeguarding level D as described in EN 12453 (also called protection  device). The use of a protection  device on its own cannot guarantee compliance with the requirements of EN 12453, it shall always be used in conjunction with a system to limit the forces of the barrier (safeguarding level C).

For protection  installation, make sure that the test input of the EVOLOOP is connected, and that it is tested before every movement of the barrier. If the test input is not used, the proper functioning of the EVOLOOP shall be checked at intervals not greater than 6 months.

For protection  installation, make sure the EVOLOOP is positioned at maximum 50 cm from the boom (page 6 - point 3).

- The sensor cannot be used for purposes other than its intended use.
- The manufacturer of the gate system incorporating the sensor is responsible for compliance of the system to applicable national and international regulations and safety standards.
- The installer must read, understand and follow the instructions given in this manual. Improper installation can result in improper sensor operation.
- The manufacturer of the sensor cannot be held responsible for injury or damage resulting from incorrect use, installation or inappropriate adjustment of the sensor.

2. DESCRIPTION

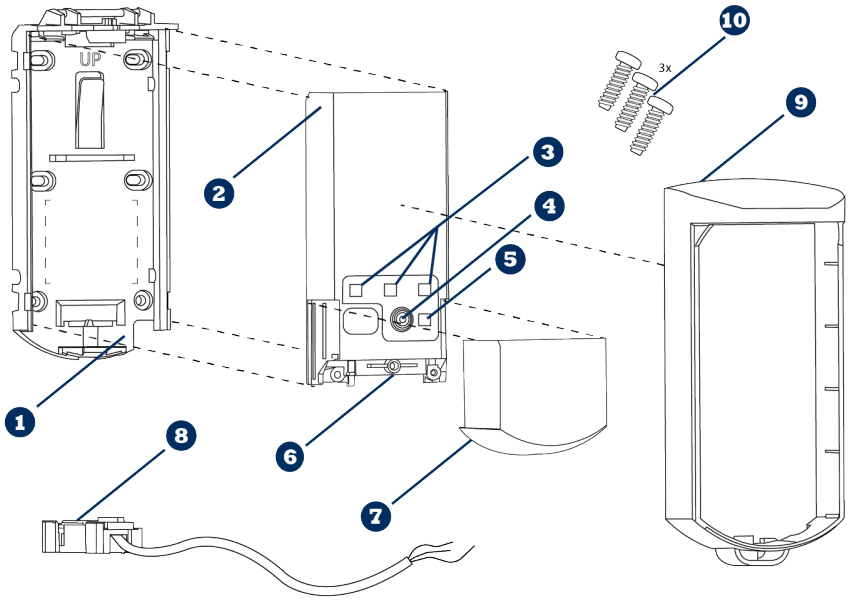

- 1** Mounting Support
- 2** Sensor
- 3** 3 virtual loop LEDs
- 4** Push Button
- 5** Bluetooth® LED
- 6** Connector socket
- 7** Sliding Cover
- 8** Cable & Connector plug
- 9** Protective Cover (Plastic)
- 10** 3 screws kit (M3 - Torx 10)

3. VERSIONS

Plastic version **Metallic version**

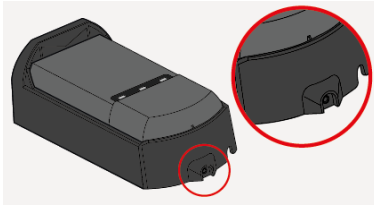
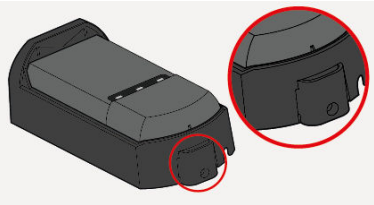

4. LED SIGNAL

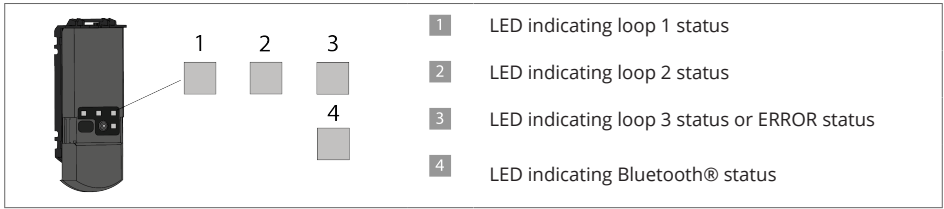

LED - WORKING PRINCIPLES

- LED is OFF
- Green LED is ON
- Green LED blinks slowly
- Green LED blinks
- Red LED blinks quickly
- Red LED and Green LED blinks
- Orange LED blinks x times

LED - LOOP TYPE

- Presence Loop:** triggers output if a target is detected on the loop with selected type and direction.
- Protection Detection:** triggers output for any object
- Bluetooth® (only on LED 4)

5. TIPS

INSTALLATION TIPS

✔	✔	✔	✔
Always test the good functioning of the installation before leaving the premises.	Only trained and qualified personnel may install and setup the sensor.	Always mount the mounting support perpendicular to the barrier arm or boom.	Use stainless screws (M4) to fit the mounting support. Secure the mounting support on its support with at least 4 screws.
✘	✘	✘	
Avoid vibration, condensation, sudden and extreme temperature changes	Do not cover the product front face	Avoid presence of metallic parts in the sensor's close environment that may obstruct the detection field.	

MAINTENANCE TIPS

✔	✔	✔
Make sure the front face is clean		
✘	✘	✘
Avoid direct exposure to high pressure cleaning	The warranty is invalid if unauthorized repairs are made or attempted by unauthorized personnel.	Do not apply solvent-base or oily product on the sensor.

6. DETECTION FIELD

FIELD OF VIEW

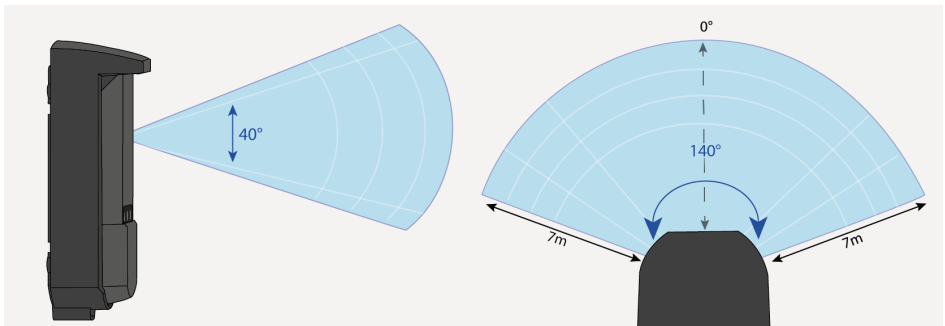

APPLICATION EXAMPLE - PRESENCE AND PROTECTION[®] CONFIGURATION

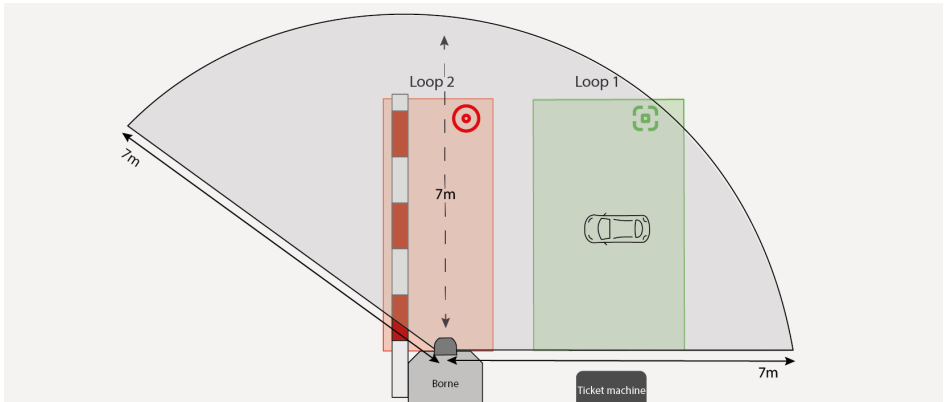

Protection[®]



Presence

7. MOUNTING THE SENSOR

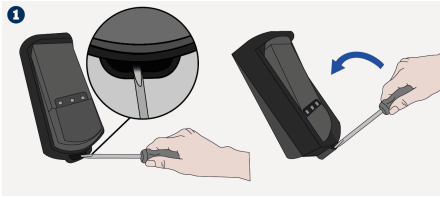

1. **Remove the plastic or metallic protective cover.**

For the plastic protective cover, insert a screwdriver into the provided notch at the bottom of the product. Lever it up to remove the protective cover from the mounting support.

For the metallic protective cover, unscrew and remove the protective cover.

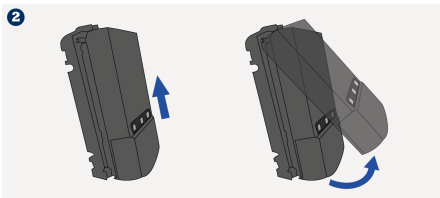

2. **Remove the sensor from the mounting support.** Push the product upwards and separate it from the product base.

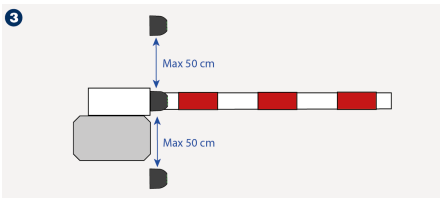

3. **If the sensor is used to detect, to reduce risk of collision or as a protection D device** it is recommended to position the product at a maximum distance of 50cm from the boom.

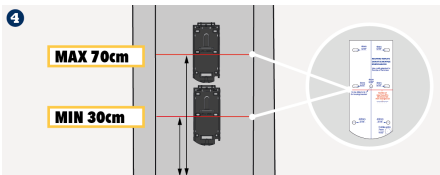

4. **Position the sensor as low as possible**, between 30cm and 70cm from the road ground. You can use the mounting template.

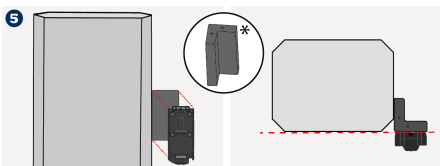

5. **Mount the sensor on the cabinet or use the bracket accessory*.** When using the bracket accessory, make sure the sensor is aligned with the cabinet to avoid obstruction of the detection field.

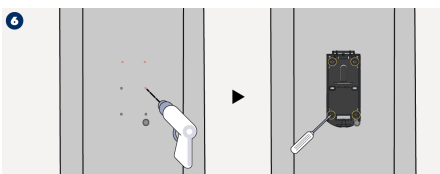

6. **Fix the mounting support according to your preference.** The mounting support needs to be fixed firmly and securely!

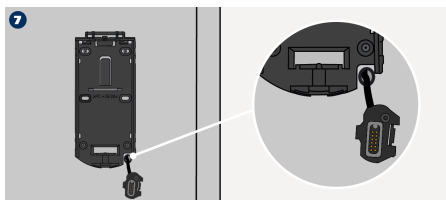

- 7. Prepare the cabling.** Take the cable and pass the cable through the hole. Make the connector plug hang down 10 cm.

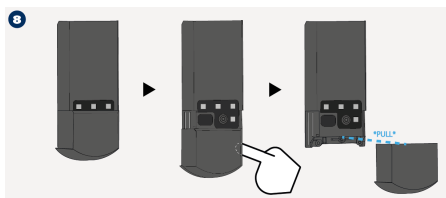

- 8. Remove the sliding cover**
First lower the sliding cover, then, place your finger behind the cover and pull to take it off.

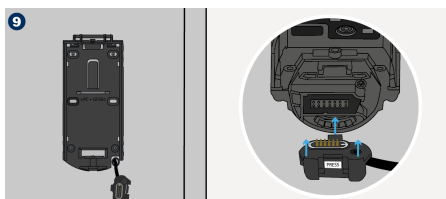

- 9. Connect the plug. You can use a provided screw**
If needed use a provided screw to firmly fix the connector plug to the sensor.

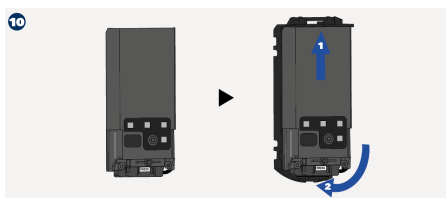

- 10. Place the sensor on the mounting support.** First insert the top and then the bottom of the product. Make sure the product is firmly fixed in the mounting support.

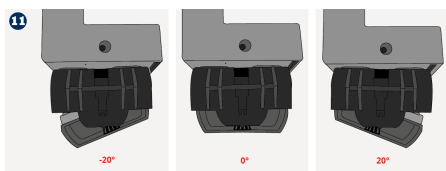

- 11. Rotate the sensor**
Depending on the mounting position and the traffic flow direction you can rotate the sensor. To do so, lift the sensor up and turn it accordingly.

8. ACCESSORIES



PROTECTIVE COVER



BRACKET

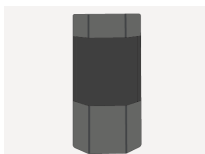

HOUSING

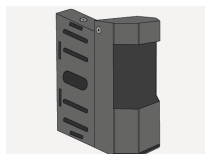

BRACKET & HOUSING

9. CONNECTING THE SENSOR (EXAMPLE)

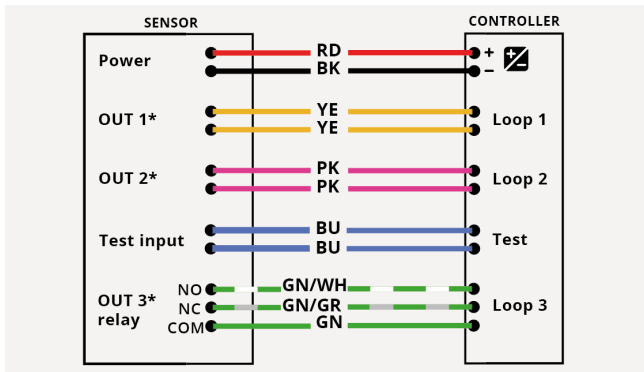
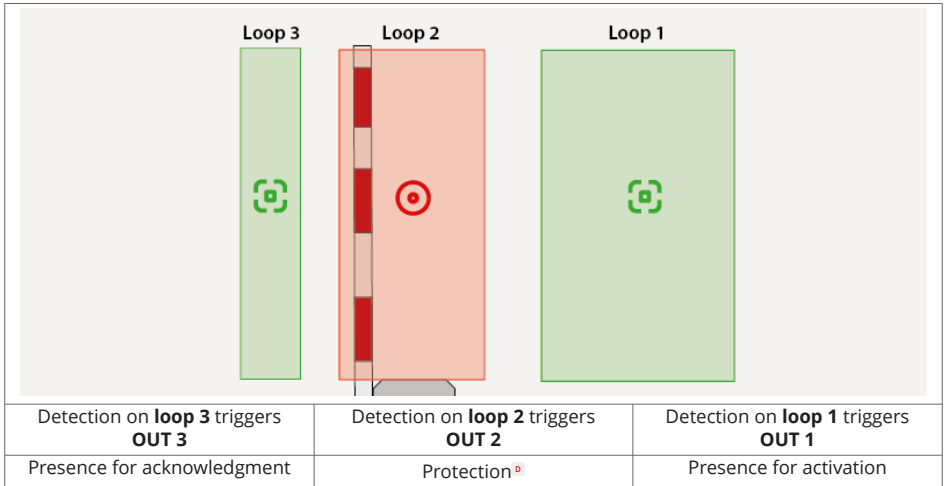

*Always check output logic factory values.

10. INSTALLATION VIA APP

Scan the QR code or open the following link to download the mobile application and install it.

<https://play.google.com/store/apps/details?id=com.beasensors.evoloop>

<https://apps.apple.com/us/app/evoloop/id6474297732>



At power ON or after a power cycle, the Bluetooth® keeps activated 30 minutes after last use and then turns off automatically.

The white Bluetooth® LED blinks (1Hz).

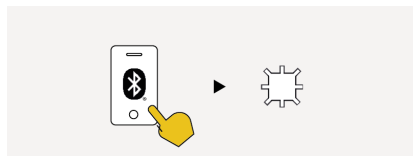

Open the Evoloop mobile app and connect it to the sensor. During pairing, the Bluetooth® LED blinks quickly.

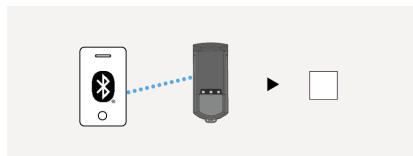

Once paired, the white Bluetooth® LED is on.

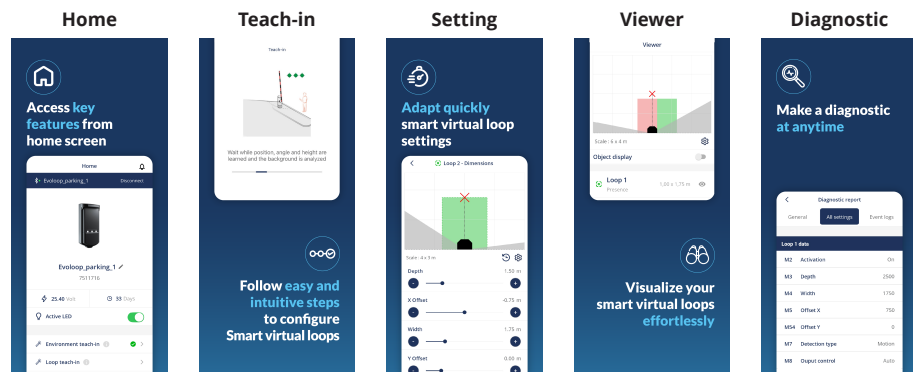

The Bluetooth® word mark and logos are registered trademarks owned by Bluetooth SIG, Inc. and any use of such marks by BEA sa is under license. Other trademarks and trade names are those of their respective owners

11. INSTALLATION VIA BUTTON

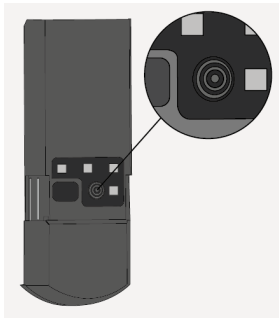

Push 1x

Wake Up from idle mode - Bluetooth® is activated. (White blinking)

Push 1x

Launch full teach-in, when sensor is awake. (Red/Green blinking)

Push 2x

Launch loop teach-in, when sensor is awake. (Alternative green blinks)

Push > 3s

Service mode activation/deactivation

12. LOCK/CLOSE THE SENSOR

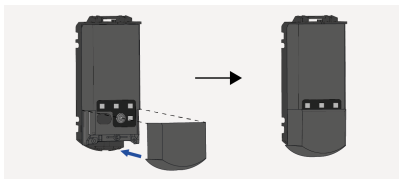

Put the sliding cover back in place.

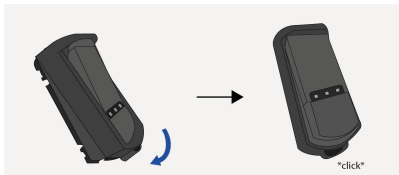

Put the protective cover back in place. If needed use the screw to firmly fix the cover.

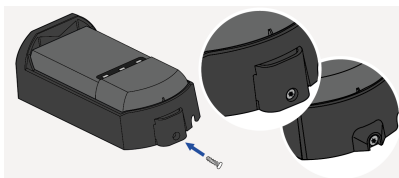

With both the plastic and metallic versions you can use screws (TORX 10).

13. TEACH-IN



NOTE

Make the teach in with mobile app or using button.



CAUTION

It's mandatory to follow the installation steps in order to correctly commission the sensor and ensure the good functioning of the barrier.

1. Sensor is mounted. 2. Sensor must be correctly wired. 3. Barrier must be opened

Initial State

When the sensor is out of the box or if it has been reset to factory values, the orange LEDs blink and outputs activated.

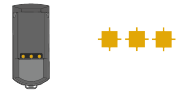

Before launching the teach-in, make sure the environment is clear of any objects and that you're standing outside of the field.

1. Teach-in steps



CAUTION

Make sure to stop the traffic, clear and stand outside the detection zone during environment teach-in.

• Environment teach-in

Launch the teach-in by using the app or press the button 1x. The first LED start blinking red-green.

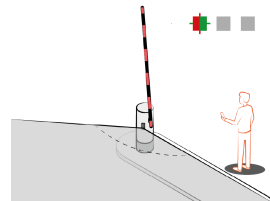

When environment teach-in is successfully done!

• **a. Boom teach-in : Closing**

The sensor deactivates its outputs for 20 seconds to signal the boom's closing. (2 LEDs red/green.)

• **b. Boom teach-in : Opening**

The sensor reactivates its outputs for 20 seconds to signal the boom's opening. (3 LEDs red/green.)

This procedure is always required.



CAUTION

Make sure to stop the traffic, clear and stand outside the detection zone during boom teach in.



NOTE

Boom and equipment fitted (skirt pendulum) are in good and functional state.

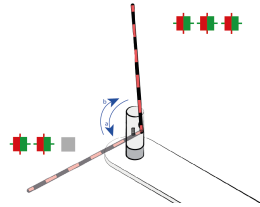

2. **Edge teach-in**

Once the boom teach-in is completed successfully, the product waits for you to indicate the length of the boom.

Stand in front of the sensor at a distance equal to the boom length or the road width. During the waiting period, the green LEDs blink.

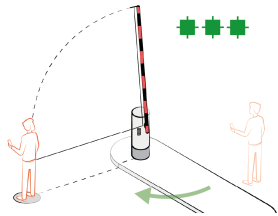

3. **Finish**

Stand still the LEDs blink red to indicate the sensor has locked your position and the process is completed successfully.

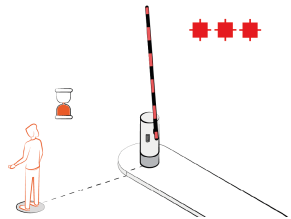

14. LOOP TEACH IN



CAUTION

It's mandatory to follow the installation steps in order to correctly commission the sensor and ensure the good functioning of the barrier.



NOTE

Mobile App Loop configuration is possible by using the app.

1. Loop Selector

Select the loop you want to configure by static Teach-In

Loop 1, push when LED 1 is ON,

Loop 2, push when LED 2 is ON

Loop 3, push when LED 3 is ON

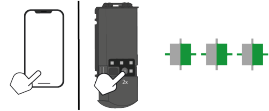

2. Static Teach-In (Button & App)

When the green LEDs start blinking slowly, go to the centre of the loop and stand still. Once the red LEDs are blinking, the teach-in of the loop is completed successfully.

By default loop's depth is set to 1.5m and width to distance learned during edge teach-in

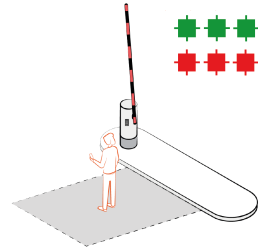

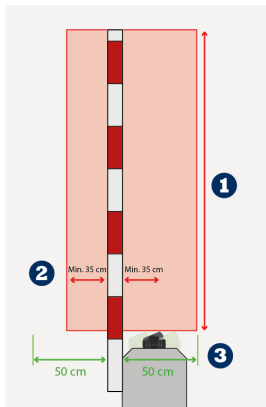

15. PROTECTION

BOTH SIDE PROTECTION







1) Set the protection  loop width to cover the whole length of the boom.

2) Set the protection  loop depth to include the whole of the EVOLOOP and to reach at least 35 cm behind the opposite face of the boom.

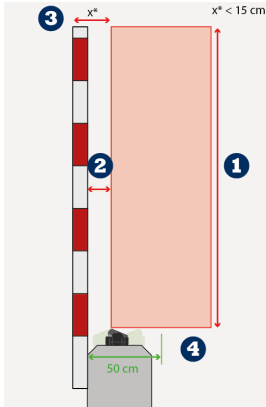





3) Always rotate the sensor so that the Evoloop is pointing towards the protection  loop

ONE SIDE PROTECTION



- 1) Set the protection  loop width to cover the whole length of the boom.
- 2) Set the protection  loop offset to include the whole of the EVOLOOP and to get as close as possible to the boom face.
- 3) This type of installation can only be used if the distance between the protection  loop and the opposite face of the boom is less than 150 mm.
- 4) Always rotate the sensor so that the Evoloop is pointing towards the protection  loop

16. TROUBLESHOOTING

LED	Status	Explanation/Solution
	The error LED (3) is on permanently	The sensor encounters a memory problem. Replace sensor.
	LED 1 - 2 - 3 are blinking orange	The product is in initial state Initiate a teach-in to commission the sensor use the mobile app or the button
	The error LED (3) blinks 1x	The sensor signals an internal fault Cut and restore power supply. LED blinks again, replace sensor
	The error LED (3) blinks 2x	Power supply is out of limit. 1. Check power supply 2. Reduce the cable length or change cable Internal temperature is too high. Protect the sensor from any heat source (sun, hot, air...)
	The error LED (3) blinks 3x	Internal communication error. Cut and restore power supply. LED blinks again, replace sensor.
	The error LED (3) blinks 4x	Masking Error Something close to the sensor is masking part of the detection field. 1. Remove all masking elements (very close metallic elements) 2. Verify if the front face is dirty and clean it carefully. 3. Switch antimasking setting to off by using the mobile app.

17. TECHNICAL SPECIFICATION

Technology	FMCW, Mowa inside (microwave)
Radiated frequency	60 GHz
Max Detection Field	Up to 7m
Radiated power	< 20 dBm EIRP
Radar Field of view	140° opening field and 40° in elevation
Reference body for Safeguarding Level D	Corner reflector with RCS = 0.17m ²
Antenna angle adjustment	-20° to +20 °
Supply voltage*	12 – 30V DC +/-10% - 12-24V AC +/-10%
Max Power consumption	<3W
Peak Current at power-on	1.3A
Cable Length	3m (standard)
Response Time	Typical 100ms (max 250ms)
Test input Max. contact voltage Voltage Threshold	1 optocoupler (galvanic isolated – polarity free) 30 V DC (over voltage protected) Log. H: >8 V DC; Log. L: < 3 V DC
LED	3 RGB LED and 1 white LED for Bluetooth®
Dimensions	50 mm x 150 mm x 68mm (form factor)
Temperature range	-25°C to +55°C **; 0-95% relative humidity, non condensing
Degree of protection	IP65 (IEC/EN 60529)
Material	PC / ASA / Aluminium ADC12 – black color
Bluetooth®	Operating bandwidth: 2402 MHz – 2480 MHz Maximum transmitted power: 12 dBm

Outputs*	
<u>Electronic relays (galvanic isolated – polarity free)</u>	2
Max. switching voltage	35 V DC / 24 V AC
Max. switching current	80 mA (resistive)
Switching Time	tON= 5ms; tOFF = 5ms
Output Resistance	Typ 30 ohms
Voltage drop on output	< 0,7V @ 20mA
Leakage current	<10µA
<u>Relay</u>	1
Max. switching voltage	30VAC / 42V DC
Max. switching current	1A
Max. switching Power	30W





CAUTION

* External electrical sources must ensure double insulation from primary voltages.

** When using AC supply, the maximum temperature is limited to 50°C.

Specifications are subject to change without prior notice. All values measured in conditions and with a temperature of 25°C

18. CONFORMITY

<p>BEA hereby declares that this product is in compliance with European legislation 2014/53/EU (RED) and 2011/65/EU (RoHS).</p> <p>The complete declaration of conformity is available on our website.</p>	
<p>This product should be disposed of separately from unsorted municipal waste.</p>	



WWW.BEASENSORS.COM

BEA SA | LIEGE Science Park | ALLÉE DES NOISETIERS 5 - 4031 ANGLEUR [BELGIUM] | T +32 4 361 65 65 | F +32 4 361 28 58 | info-eu@beasensors.com | WWW.BEASENSORS.COM



A **Halma** company

Manufactured by: BEA SA - LIEGE Science Park - Allée des Noisetiers 5 - 4031 Angleur - Belgium - T +32 4 3616565 - F +32 4 3612858 - info-eu@beasensors.com - www.beasensors.com

PLEASE KEEP FOR FURTHER USE - DESIGNED FOR COLOUR PRINTING

©BEA Sensors | Original Instructions | 47.0859.02 | 05.25