

KCOM2

Instructions and warnings for installation and use



Management
System
ISO 9001:2015

www.tuv.com
ID 9105043769

INDEX

1. GENERAL WARNINGS FOR THE INSTALLER	3
1.1 - GUIDELINES ON ELECTRICAL CONNECTIONS	5
2. PRODUCT DESCRIPTION	6
2.1 - INTENDED USE	6
2.2 - TECHNICAL CHARACTERISTICS	6
2.3 - OVERALL DIMENSIONS	7
2.4 - BATTERIES *	7
3. RECEIVER "COMRX2"	8
3.1 - DESCRIPTION OF THE RECEIVER	9
3.2 - ADVANCED RADIO CHECK FUNCTION	9
4. TRANSMITTER "COMTX2"	10
4.1 - DESCRIPTION OF THE TRANSMITTER	10
5. ASSEMBLY AND INSTALLATION	11
5.1 - FIXING THE DEVICES AND INSTALLATION ADVICE	11
5.2 - CONNECT THE RECEIVER TO THE CONTROL PANEL	12
5.3 - CONNECT THE SENSITIVE SAFETY EDGE TO THE TRANSMITTER	13
6. PROGRAMMING	13
6.1 - ASSOCIATION BETWEEN COMTX2 AND COMRX2 (LEARNING)	13
6.2 - TOTAL DELETION OF MEMORY	14
7. MAINTENANCE	14
8. PRODUCT DISPOSAL	14
9. SYSTEM DIAGNOSTIC	15
10. CONNECTIONS TO CONTROL UNITS	16-18
11. EU DECLARATION OF COMFORMITY	19

1. GENERAL WARNINGS FOR THE INSTALLER

DANGER

RISK OF ELECTRIC SHOCK, EXPLOSION OR ELECTRIC ARC

- Shut down all equipment, including connected devices, before removing any lid or door, or before installing/uninstalling accessories, hardware, cables or wires, except for the conditions specified in the user manual for this equipment.
- To verify that the system is out of voltage, always use a correctly calibrated voltmeter at the rated value of the voltage.
- Before returning the live unit, reassemble and secure all covers, hardware and cables. Make sure that the cable inlet is sealed to prevent insect entry and moisture formation.
- Use this equipment and all products connected only to the specified voltage.
- If there is a risk of damage to personnel and/or equipment, use the necessary safety interlocks.
- Do not disassemble, repair or modify the equipment.
- This product is not suitable for installation in applications where it may come into contact with explosive or flammable atmosphere.

Failure to comply with these instructions will result in death or serious injury.



DANGER

RISK OF ELECTRIC SHOCK AND/OR FIRE

- Do not expose the equipment to liquid substances.
- Do not exceed the temperature and humidity ranges specified in the technical data and leave the slit area ventilated.
- Only connect compatible accessories in the user manual.
- Use only cables of appropriate cross-section as indicated in the section "GUIDELINES FOR ELECTRICAL CONNECTIONS". Tighten the connections in accordance with the technical specifications for the tightening torques and verify the correct wiring.
- Electrical cables must not come into contact with parts that can heat and parts of the automation in motion.

Failure to comply with these instructions will result in death or serious injury.



DANGER - BATTERIES

RISK OF OVERHEATING, EXPLOSION, FIRE OR BURN

- If the battery is intact, store and handle carefully, there is no danger (it is recommended to handle the batteries in a ventilated place, do not smoke, eat or drink during assembly).
- Do not expose to temperatures above 100 °C (temperature <85 °C recommended).
- Avoid short circuit, crushing and exposure to heat sources.
- Do not disassemble, drill, heat or wet batteries or battery packs, do not throw batteries into the fire.
- Substances to avoid: water, oxidizing agents, alkalis.
- Keep new and used batteries out of the reach of children.
- If the battery compartment does not close tightly, suspend the use of the product and keep it out of reach of children.
- If you suspect that the batteries have been swallowed or inserted into other body orifices, seek medical attention immediately.
- Only use batteries of the specified type. Risk of explosion if battery is replaced with wrong type.

Failure to comply with these instructions will result in death or serious injury.



WARNING

RISK OF OVERHEATING AND/OR FIRE

- Do not use with loads other than those indicated in the technical data.
- Power lines and output connections must be properly wired and protected by fuses when required by national and local regulatory requirements.

Failure to comply with these instructions may result in death, serious injury or damage to equipment.



WARNING

GENERAL ASPECTS OF SAFETY AND REGULATORY INCOMPATIBILITY

- Any use of this product other than the permitted use /intended use is prohibited.
- The manufacturer cannot be held liable for damage that occurs as a result of improper use or as a result of an installation that does not comply with the requirements of this manual.
- The liability of the manufacturer for damages resulting from accidents of any nature caused by defective products, are only those provided for by legal obligations.
- All operations indicated in this manual must be carried out exclusively by experienced, qualified and trained personnel.
- The preparation of the cables, the laying, the connection and the testing must be carried out observing the rule of art, in compliance with the rules, regulations and laws in force.
- During installation, testing and maintenance, properly delimit the entire site to avoid access by unauthorized persons, in particular minors and children.
- Before proceeding with the installation, check the mechanical goodness of the movable door and the support and guide structure.
- Keep this manual in the technical file together with the manuals of the other devices used for the realization of the automation system.
- Ensure that all equipment used and systems designed comply with all applicable local, regional and national regulations and regulations.

Failure to comply with these instructions may result in death, serious injury or damage to equipment.

- The data included in this manual have been compiled and verified with the utmost care, however the manufacturer cannot accept any responsibility for any errors, omissions or approximations due to technical or graphic requirements.
- The manufacturer reserves the right to change the specifications of the appliance without prior notice.
- The manufacturer recalls that this manual does not replace the provisions of the rules that the manufacturer of the motorized door/gate is required to comply with.

The manufacturer assumes no liability for any consequences arising from the misuse of this material.



WARRANTY - The manufacturer's warranty is valid by law from the date printed on the product and is limited to the free repair or replacement of parts recognized by the manufacturer as defective due to lack of essential qualities in the materials or for errors in the production process. The warranty does not cover damage or defects due to external agents, lack of maintenance, overload, normal wear, installation error, or other causes not attributable to the manufacturer. Tampered products will not be covered by warranty. The manufacturer is not responsible for malfunctions or degradation of performance due to environmental interference, such as electromagnetic disturbances; therefore, the warranty expires in these situations.

1.1 - GUIDELINES ON ELECTRICAL CONNECTIONS

Prepare cable ducts on the installation site.

The cables for the connection of the various devices in a typical plant are listed in the table below and must be suitable for the type of installation, for example we recommend a cable type H07RN-F for outdoor installation.

CONNECTION	CABLE	LENGTH
Power supply voltage - receiver	2 x 1,5 mm ²	< 20 m
Connection to the control panel	2 x 0,5 mm ²	< 20 m

The following table shows the type and size of the allowable cables for the screw terminals of the above type and the tightening torques:

mm ²	0.2 ... 2.5	0.2 ... 2.5	0.25 ... 2.5	2 x 0.2 ... 0.75	2 x 0.2 ... 0.75	2 x 0.25 ... 0.75	2 x 0.25 ... 0.75	2 x 0.5 ... 1.5
AWG	24 ... 14	24 ... 14	24 ... 14	24 ... 14	2 x 24 ... 18	2 x 24 ... 18	2 x 24 ... 18	2 x 20 ... 16

<p>Ø 3.5 mm (0.14 in.)</p>		N • m	0.5
		lb-in	4.5

Use copper conductors (mandatory).

Avoid the presence of wires of exposed branches or coming out of the clamp.

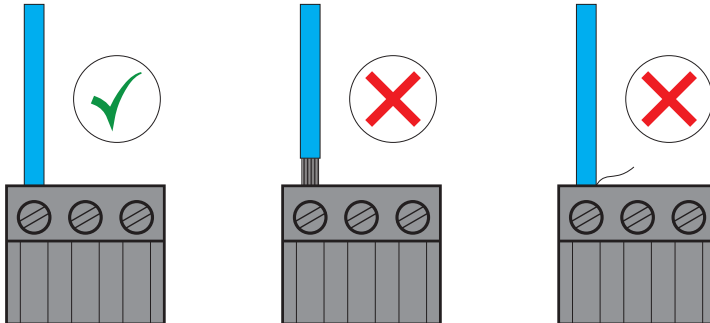

2. PRODUCT DESCRIPTION

The COMTX2 system allows radio (wireless) operation to transmit the signal of a sensitive safety edge to the control unit (CU). The receiver (COMRX2) constantly checks the status of the transmitters connected to it (COMTX2) and automatically selects the transmission frequency that guarantees the best communication quality among those available. The receiver sets its output to alarm state when an obstacle is detected from the sensitive safety edge connected to the transmitter. Up to two COMTX2 can be connected to an COMRX2. Each COMRX2 has two outputs that can be connected to the control unit.

WARNING! The KCOM2 system is not backward compatible with the previous KCOMW, as it uses a new radio communication protocol.

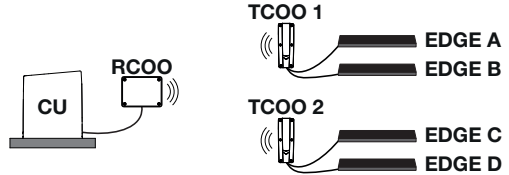

2.1 - INTENDED USE

Radio system for connecting sensitive safety edges to control panels for the automation of residential, commercial and industrial doors and gates.

If the door control panel carries out a diagnostic check of the system prior to each movement, this product allows to realize a protection system type PL "c" -CAT 2 according to EN ISO 13849-1:2015.

The diagnostic control consists of sending a polarised test command (Vtest) to the receiver and verifying that the output contact is in the alarm position. After that the test command may be interrupted.

Any installation and use different from what is indicated in the following manual are prohibited.

2.2 - TECHNICAL CHARACTERISTICS

Commercial name	COMTX2	COMRX2
The product complies with the following Directives and Harmonized Standards	2014/53/UE RED	
Construction of the device	Electronic device with independent installation	
Purpose of the device	Safety device EN ISO 13849-1:2015 category 2	
Width of the communication channel	260 KHz	
Working frequency (automatically selected)	865,2 ÷ 867,8 MHz	
Supply voltage	2 x 1,5V (alkaline LR6/AA batteries)	12 ÷ 24 Vac/dc
Current consumption COMRX2	< 70 mA @ 12Vdc	
Battery life (COMTX2) *	12 ÷ 24 months	
Radiated power	< 25 mW	
COMRX2 radio memory	MAX 2 COMTX2	
COMRX2 relay output (OUT1 / OUT2)	MAX 1 A	
Usable sensitive edge types (EDGE1 / EDGE2)	Resistive edges (8.2 K Ohm) Mechanical edges (normally closed contact)	
Maximum reaction time for safety edge intervention	40 ms	
Intervallo di diagnostica della comunicazione radio	1 s	
Maximum distance between devices (in open field)	50 m	
Environmental operating conditions	TA: -20...+55 °C RH max 90% non-condensing	
Conditions of transport and storage	TA: -40...+70 °C RH max 90% non-condensing	
Degree of environmental protection	IP65	

2.3 - OVERALL DIMENSIONS

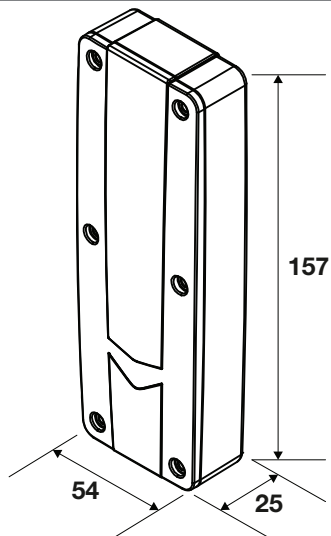
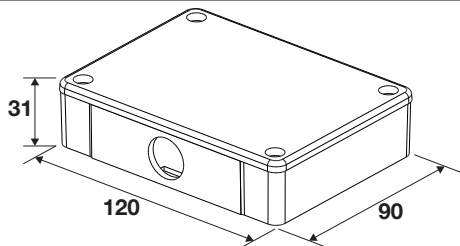

2.4 - BATTERIES *

WARNING

BATTERY LIFE AND USE

• Battery life depends on the quality of radio communication between devices. The quality of the radio communication can decrease in the presence of shielding or reflection phenomena that can occur during the movement of the automation. For this reason, the number of manoeuvres per day can also affect the total battery life. Check the signal quality with the advanced RADIO CHECK function. • Do not mix new and discharged batteries. • Before disposing of the equipment, remove the batteries and place them in an appropriate waste disposal place. Check the provisions of your municipality of residence.



WARNING

STORAGE OF BATTERIES

• Store batteries in a cool, dry place away from heat or flames. • The recommended maximum storage temperature is 30 °C. If higher temperatures are reached, batteries may become damaged and/or discharge prematurely. In any case, do not exceed 100 °C, as the batteries can be damaged causing a leak of harmful substances. • Do not subject batteries to mechanical shock or stress. • Keep batteries in their original packaging until they are used. • Do not expose batteries to direct sunlight.

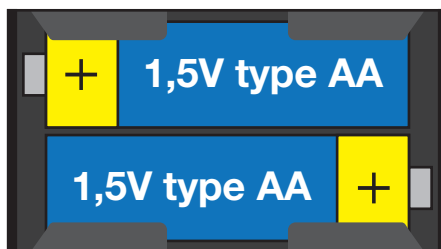

3. RECEIVER "COMRX2"

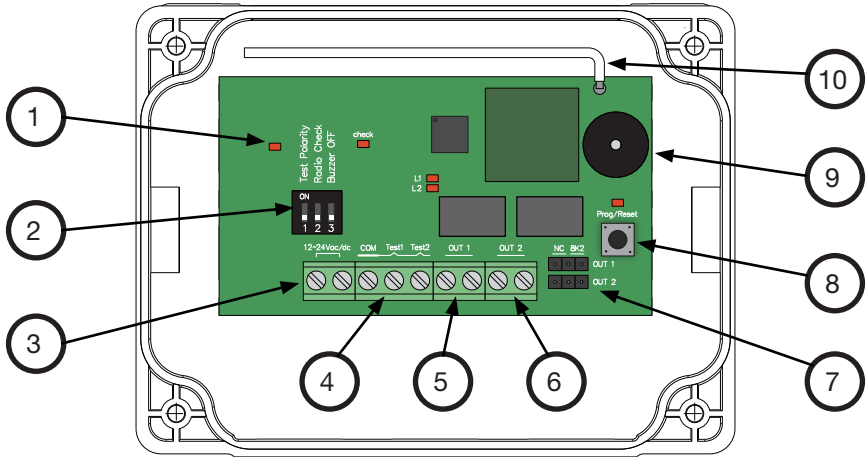

1. LED POWER ON
2. DIP-SWITCH selector for configuration (TAB.1)
3. Terminal block for connection of the supply voltage (Valim)
4. Terminal block for connection of the TEST control (Vtest)
5. Terminal block for connection of the OUT1 output
6. Terminal block for connection of the OUT2 output
7. Output Configuration Selector (TAB.2)
8. PROG/RESET button
9. Buzzer for acoustic signals
10. Antenna

LED	OFF	ON
POWER ON	COMRX2 not powered	COMRX2 properly powered
RADIO CHECK	No communication from an associated COMTX2	No associated COMTX2
L1	OUT1 output in consensus	OUT1 output in alarm
L2	OUT2 output in consensus	OUT2 output in alarm
PROG/RESET	COMRX2 in normal operation mode	COMRX2 in programming mode

TAB.1

DIP SWITCH SELECTOR	OFF	ON
1 - TEST POLARITY	Test control with positive polarization: TEST not active = 0V TEST active = 12/24vdc	Test command with negative polarization: TEST not active = 12/24vdc TEST active = 0V
2 - RADIO CHECK	Normal functionality: verification of the presence of associated COMTX2	Advanced functionality: verification of the quality of radio communication between COMRX2 and COMTX2
3 - BUZZER OFF	Enable the acoustic signals	Disable the acoustic signals

TAB.2

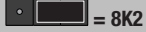
POSITION	NC 8K2  = NC	NC 8K2  = 8K2
OUT1	Consent = closed circuit Alarm = open circuit	Consent = 8K2 ohm Alarm = closed circuit
OUT2	Consent = closed circuit Alarm = open circuit	Consent = 8K2 ohm Alarm = closed circuit



3.1 - DESCRIPTION OF THE RECEIVER

The receiver, once powered, before having associated a COMTX2, looks like this:

- POWER LED on (properly powered device);
- The LED RADIO CHECK turned on fixed (no COMTX2 learned);
- Both L1 and L2 LEDs on (outputs in alarm state).

Once you have learned a COMTX2, the RADIO CHECK LED, in its normal functionality, gives immediate feedback of the radio packets received by its associated transmitters by flashing a short.

The buzzer on the board allows you to have immediate acoustic information on the diagnostics of the associated transmitters, depending on the number of acoustic signals emitted.

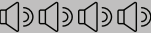
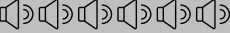
ACOUSTIC SIGNALS	DESCRIPTION	ASSOCIATED OUTPUT
1 - 	Press the TEST button of an associated COMTX2.	Consent
2 - 	Input of a COMTX2 associated in alarm.	Alarm
4 - 	Notice of battery replacement of an associated COMTX2.	Consent
6 - 	Failure to communicate with an associated COMTX2.	Alarm

When the batteries on the transmitter are almost empty and reach the voltage of 2.1V, the receiver warns the user of the imminent need to replace the batteries by performing 4 beeps every minute. During these reports the system is still working, but it is advisable to consider whether to proceed to the replacement of the batteries before the automation stop occurs.

In case of no communication with an associated COMTX2, the receiver will perform 6 beeps every minute and will bring all its outputs in alarm state.

3.2 - ADVANCED RADIO CHECK FUNCTION

WARNING



- Low signal coverage results in increased battery consumption.



The RADIO CHECK function allows to know the quality of the radio communication between a COMTX2 and an COMRX2. This characteristic may depend on the presence of devices that generate radio noise, or phenomena of shielding and reflection due to metal bodies present in the installation itself.

In this mode the RADIO CHECK LED performs a number of flashes every second proportional to the quality of the radio coverage at that time. It is therefore advisable to perform some complete movements of the automation so that you can evaluate the overall quality of radio communication between the devices in your installation.

- To activate the RADIO CHECK mode, move the DIP-SWITCH on the COMRX2 to the ON position.
- Press a safety edge to start displaying the status of the radio transmission between the COMTX2 to which that safety edge is connected and the associated receiver.

LED RADIO CHECK	DESCRIPTION
1 - 	Low radio coverage.
2 - 	Medium radio coverage.
3 - 	Good radio coverage.

- Once all the checks are completed, you can return the DIP-SWITCH switch of the COMRX2 to the OFF position to exit the RADIO CHECK function.

4. TRANSMITTER "COMTX2"

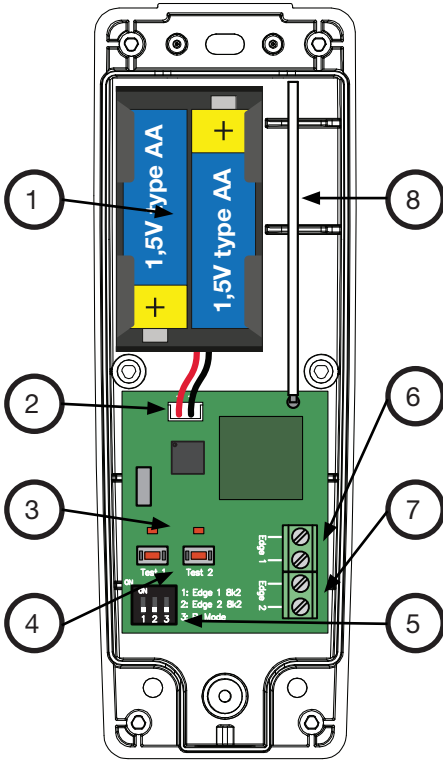

1. Housing for the batteries
2. Connector for connecting the batteries
3. LED TEST1 and TEST2
4. TEST1 and TEST2 buttons
5. DIP-SWITCH selector for configuration (TAB.3)
6. Terminal block for connecting the safety sensitive board (EDGE1)
7. Terminal block for connecting the safety sensitive board (EDGE2)
8. Antenna

LED	OFF	ON
TEST1	-	Pressing the TEST1 button
TEST2	-	Pressing the TEST2 button

TAB.3

DIP SWITCH SELECTOR	OFF	ON
1 - EDGE 1 8K2	Safety sensitive edge, mechanical type (Normally Closed contact) connected to the EDGE1 input	Safety sensitive edge, resistive type (8K2 OHM) connected to EDGE1 input
2 - EDGE 2 8K2	Safety sensitive edge, mechanical type (Normally Closed contact) connected to the EDGE2 input	Safety sensitive edge, resistive type (8K2 OHM) connected to EDGE2 input
3 - P. MODE	Not used	

4.1 - DESCRIPTION OF THE TRANSMITTER

WARNING

- Do not transport or store the COMTX2 with batteries connected to the board.



Once it is associated with an COMRX2, the transmitter sends the information to the receiver once every second and every time the sensitive safety edge connected to its terminals detects an impact or is disconnected.

5. ASSEMBLY AND INSTALLATION

5.1 - FIXING THE DEVICES AND INSTALLATION ADVICE

WARNING

- Grommets and gaskets must be installed to ensure IP65 protection.
- Replace the grommets with caps on the holes that are not used.
- Install the devices so that the output of the cables is facing down.
- Always maintain a minimum distance of at least 20 cm between the transmitter and the receiver.
- Do not place metal surfaces between transmitter and receiver.
- To maximize the range of action, both devices must be installed with the same orientation (horizontally or vertically) and at the same height.
- Do not place the equipment at ground level.

Failure to comply with these instructions can cause a significant drop in system performance, resulting in possible automation stop.

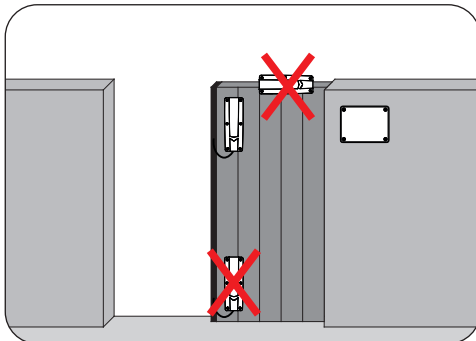
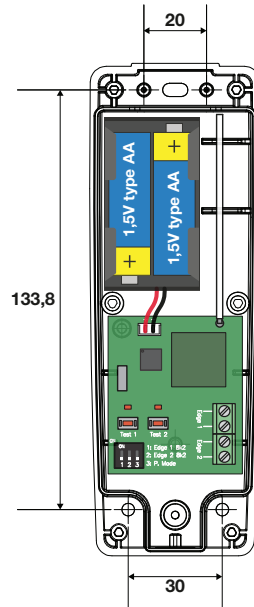
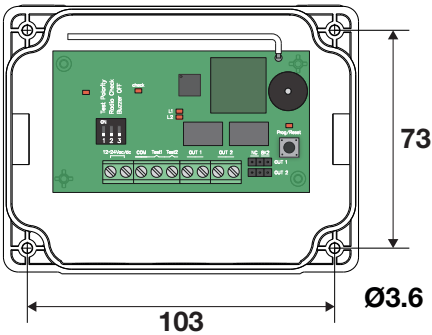

5.2 - CONNECT THE RECEIVER TO THE CONTROL PANEL

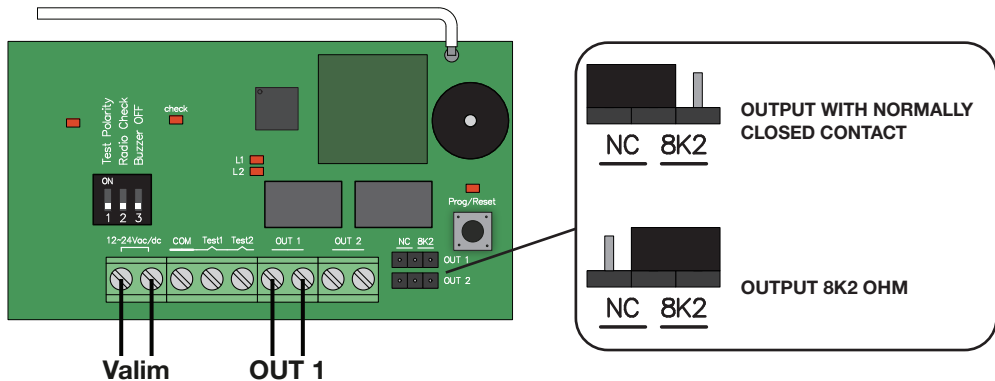

- Connect the supply voltage (Valim) to the COMRX2 board.
- Connect the desired output (OUT 1 and/or OUT 2) to the control unit. You can connect this output to an 8K2 safety edge input or directly into a safety input with normally closed contact (such as a photocell input or a STOP input).
- Depending on the input type used in the control unit, select the corresponding type with the use of a jumper.
- Set the DIP-SWITCH 1 to select the polarity of the test command.

TEST POLARITY



ON

NEGATIVE POLARIZATION:

The test control is a fixed 12 or 24V signal, which the control unit brings to 0 to carry out the system verification.



OFF

POSITIVE POLARIZATION:

The test control shall be voltage-free. The control unit shall carry this control at 12 or 24V to verify the system.

WARNING

- If the control unit is working without a test control, the TEST POLARITY selector must be set to POSITIVE POLARITY (OFF position).
- In order to realize a protection system type PL "c" -CAT 2 according to EN ISO 13849-1:2015 you need to connect the test command (Vtest).



CONNECTION OF THE TEST CONTROL

Use the TEST1 input for the test run on the OUT1 output.
Use the TEST2 input for the test run on the OUT2 output.

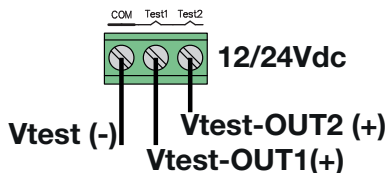

5.3 - CONNECT THE SENSITIVE SAFETY EDGE TO THE TRANSMITTER

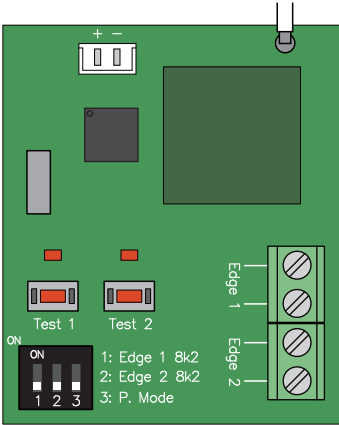

- Connect the safety sensitive edge to the desired input (EDGE1 or EDGE2).
- Depending on the type of edge used, select the corresponding type in the DIP-SWITCH selector.

Configuration example for EDGE1 input:

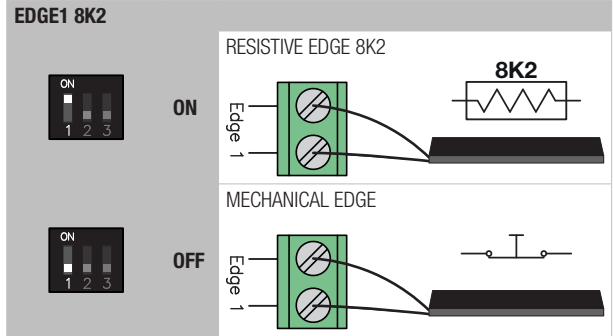

- Insert the battery into the dedicated housing and connect the connector to the board.

6. PROGRAMMING

6.1 - ASSOCIATION BETWEEN COMTX2 AND COMRX2 (LEARNING)

WARNING

- The learning procedure is automatically abandoned for TIME OUT after 30 seconds from the last key pressed on the COMRX2.
- During the learning procedure both outputs remain alert.
- You can map the association between COMTX2 input and COMRX2 outputs again by repeating the learning procedure and setting the desired configuration.



- Make sure the devices are turned on properly.
- Press and hold the PROG/RESET button for at least 3 seconds, when the PROG/RESET LED lights up fixed release the button.
- At this stage you can select in which output (OUT1 and/or OUT2) you want to learn an input of a COMTX2. Use the PROG/RESET button to select the desired option.

LED L1	LED L2	DESCRIPTION
FLASHING	OFF	The input will be learned on the OUT1 output.
OFF	FLASHING	The input will be learned on the OUT2 output.
FLASHING	FLASHING	The input will be learned on the OUT1 and OUT2 outputs.

- Press the COMTX2 button you want to associate (TEST1 or TEST2).
- In the COMRX2 the L1 and L2 LEDs both light up and the buzzer makes two beeps to confirm the programming.
- After the procedure the LED PROG/RESET turns off.

WARNING

- **This procedure involves the cancellation of all COMTX2 learned in the receiver.**

- The cancellation procedure is automatically abandoned for TIME OUT after 10 seconds, or if the PROG/RESET key is pressed for a time not long enough.
- In case of replacement of a COMTX2 it is necessary to perform the total erasure of the memory and then re-program all the COMTX2 used.



- Press and hold the PROG/RESET button for at least 7 seconds, when the PROG/RESET, L1 and L2 LEDs flash quickly release the button.
- Within 10 seconds, press and hold the PROG/RESET button for at least 3 seconds to perform total memory erase.
- When the L1 and L2 LEDs blink slowly release the PROG/RESET button.
- The buzzer performs three audible signals to indicate correct cancellation and the PROG/RESET LED turns off.
- Below the L1, L2 and CHECK LEDs light fixed.

7. MAINTENANCE

Before carrying out any cleaning, maintenance or replacement of parts, remove power to the automation. Every 12 months of operation, the following maintenance measures are mandatory:

- Check and clean any dirt, insects and dust residues that have been placed inside.
- Check the integrity of the cables and their connections, including clamping contact, and make the necessary replacements.
- Verify the integrity of the protective shells and sensitive safety edges connected to the COMTX2, and perform the necessary replacements.
- Perform a general and complete check of the screws and bolts.
- Perform a functional product check by checking the correct operation of the switchboard in the event of an COMRX2 output alarm.
- Check battery status and replace if necessary.

8. PRODUCT DISPOSAL

As for installation operations, the disassembly of this product must be carried out by qualified personnel. The symbol on the side indicates that the product should not be disposed of as unsorted waste, but should be sent to separate collection facilities for recovery and recycling. For disposal check the recycling or disposal systems provided by the territorial regulations in force for this category of product, or return the product to the seller.

WARNING - • This product consists of various types of materials: some parts of the product may contain pollutants or dangerous substances that, if dispersed, could cause harmful effects to the environment and health. • Local regulations may provide for heavy penalties in the event of incorrect disposal of this product



9. SYSTEM DIAGNOSTIC

PROBLEM	POSSIBLE CAUSE	SOLUTION
The receiver emits 2 acoustic signals every 5 seconds.	Input of the COMTX2 in alarm.	Verify that the sensitive edge is properly connected and working.
	Incorrect setting of COMTX2 input.	Check the COMTX2 DIP-SWITCH selector setting.
The receiver emits 4 acoustic signals every minute.	Battery level of an associated COMTX2 is low.	Check the batteries of the COMTX2 and perform the necessary replacements.
The receiver emits 6 acoustic signals every minute.	Drained battery of an associated COMTX2.	Check the batteries of the COMTX2 and perform the necessary replacements
	Low radio coverage or presence of strong radio noise.	Perform the RADIO CHECK procedure to improve the installation position of the COMTX2 and COMRX2 (see chapter INSTALLATION TIPS).
Batteries in a COMTX2 drain quickly.	Low radio coverage or presence of strong radio noise.	Perform the RADIO CHECK procedure to improve the installation position of the COMTX2 and COMRX2 (see chapter INSTALLATION TIPS).
I can't do the learning.	Full radio memory.	The COMRX2 can learn a maximum of 2 COMTX2. If necessary, erase the memory and learn the COMTX2 again.

10. CONNECTIONS TO CONTROL UNITS

COMRX -> CT102B / CT103

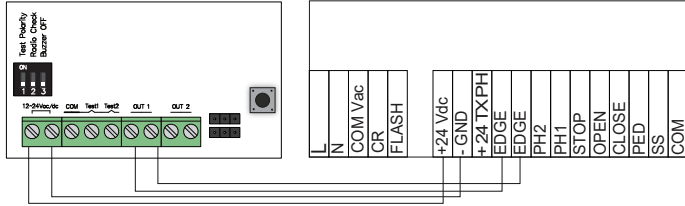

COMRX -> CT102B / CT103 WITH TEST

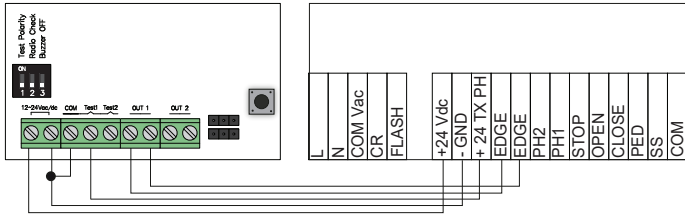

COMRX -> CT202 / CT203

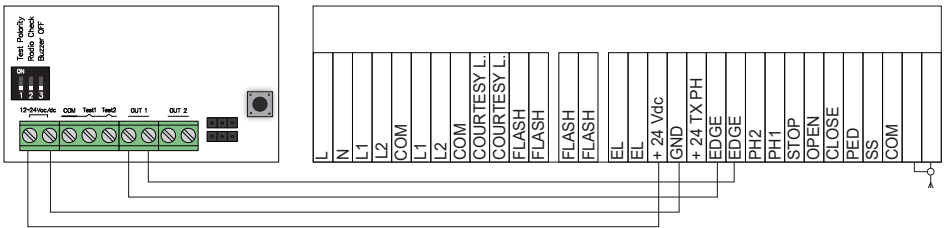

COMRX -> CT202 / CT203 WITH TEST

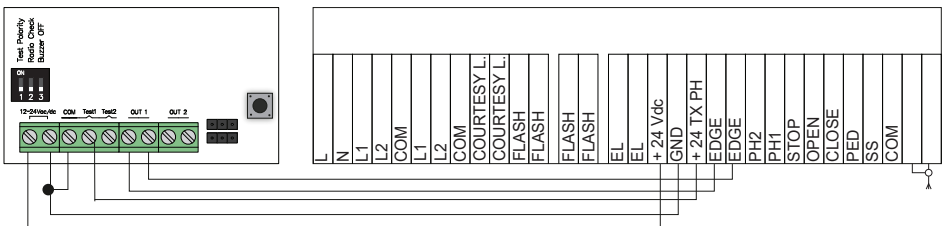

10. CONNECTIONS TO CONTROL UNITS

COMRX -> CT10324

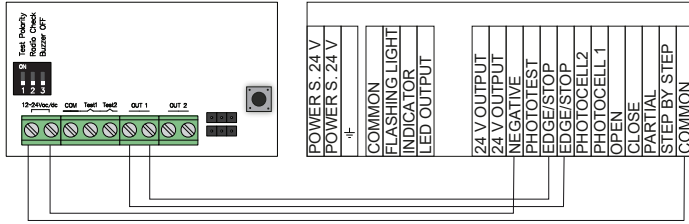

COMRX -> CT10324 WITH TEST

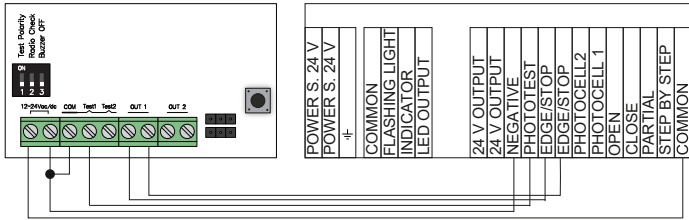

COMRX -> CT20324

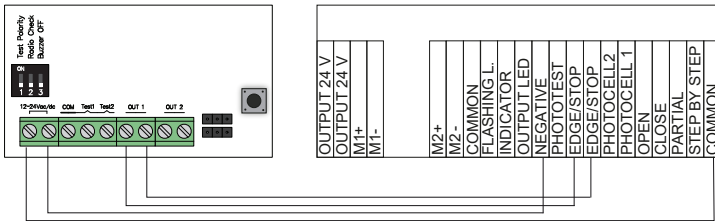

COMRX -> CT20324 WITH TEST

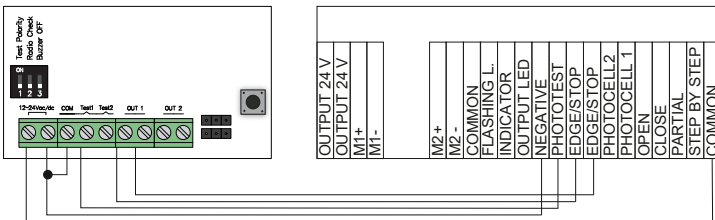

10. CONNECTIONS TO CONTROL UNITS

COMRX -> 14A

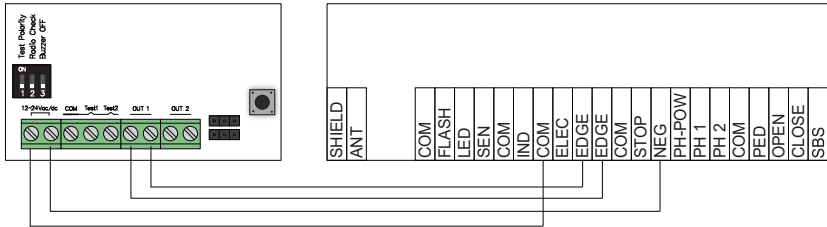

COMRX -> 14A WITH TEST

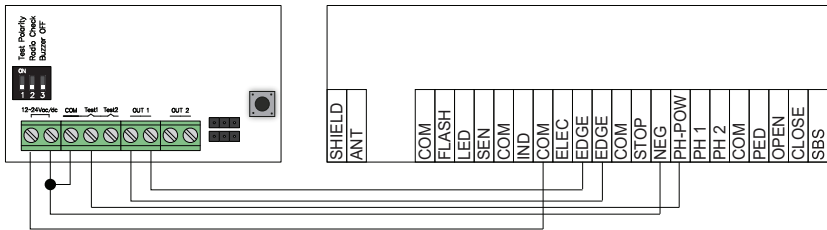

COMRX -> CT400

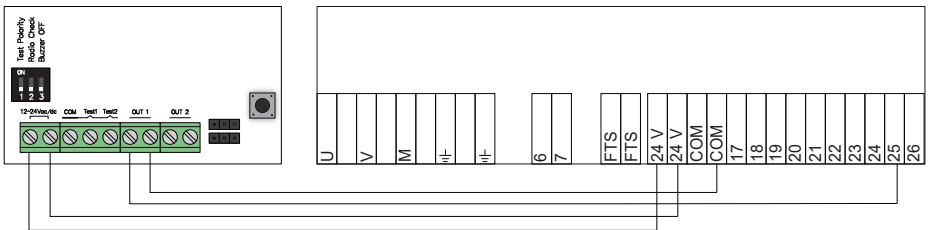

11. EU DECLARATION OF COMFORMITY

DICHIARAZIONE DI CONFORMITA' UE

EU DECLARATION OF CONFORMITY

Il sottoscritto Nicola Michelin, Amministratore Delegato dell'azienda
The undersigned Nicola Michelin, General Manager of the company

Key Automation S.r.l., via Meucci 23, 30027 San Donà di Piave (VE) – ITALIA

dichiara che il prodotto tipo:
declares that the product type:

KCOM2

Sistema radio a 868MHz per bordi sensibili di sicurezza
868MHz Radio system for sensitive safety edges

Models:

Models:

900KCOM2, 900COMTX2, 900COMRX2

E' conforme a quanto previsto dalle seguenti direttive comunitarie:
Complies with the following community (EC) regulations:

Direttiva radiofrequenza / RED Directive 2014/53/EU

Direttiva RoHS / RoHS Directive 2011/65/UE

Secondo quanto previsto dalle seguenti norme armonizzate:

In accordance with the following harmonized standards regulations:

ETSI EN 301 489-1 V2.2.3

ETSI EN 301 489-3 V2.3.2

ETSI EN 300 220-2 V3.2.1

EN 62479 :2010

La presente dichiarazione di conformità è rilasciata sotto l'esclusiva responsabilità del fabbricante.
This declaration of conformity is issued under the sole responsibility of the manufacturer.

San Donà di Piave (VE), 24/04/25

Amministratore Delegato

General Manager

Nicola Michelin



Key Automation S.r.l.
Via Meucci, 23
30027 San Dona' di Piave (VE)
P.IVA 03627650264 C.F. 03627650264
info@keyautomation.it

Capitale sociale 154.000 € i.v.
Reg. Imprese di Venezia 03627650264
REA VE 326953
<http://www.keyautomation.com/>



Organizzazione con sistema di gestione certificato

Key Automation S.r.l.

Via Meucci 23 - 30027 San Donà di Piave (VE)

T. +39 0421 307456 - info@keyautomation.it

www.keyautomation.com

Instruction version
583KCOM2 REV01